

15x15 CO Sensor 1000 ppm Package 110-109

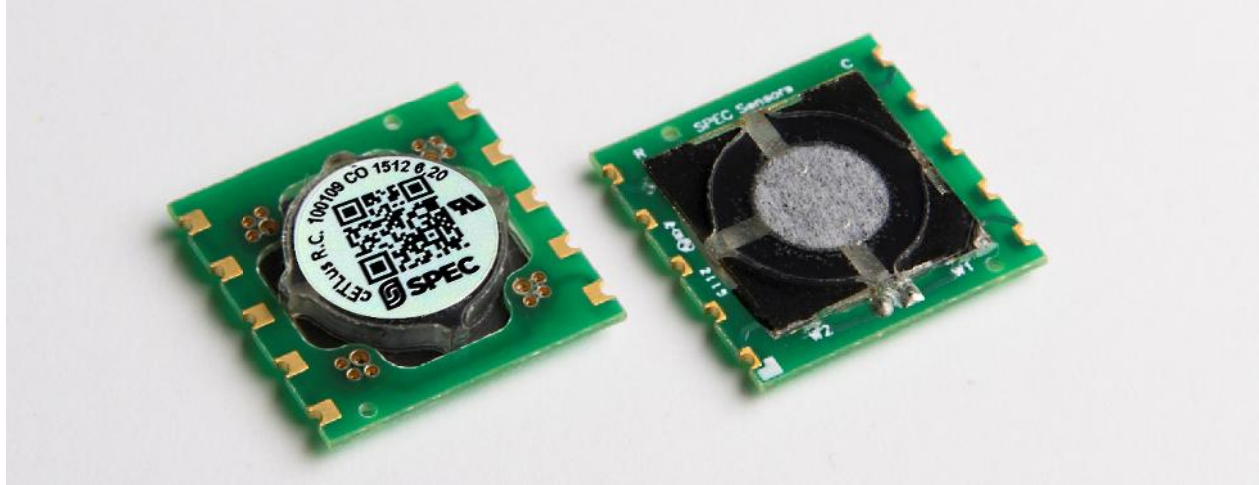

BENEFITS

- Small Size with Low Profile (20x20x3.8 mm)
- Long Life (10 years expected life)
- Fast Response (< 15 seconds)
- Robust (passes 5000 ppm overload)
- Low Power (0 mW @ 0 mV bias)
- Individually Calibrated (NIST Traceable)
- ROHS Compliant

APPLICATIONS

- Residential and Commercial CO Monitoring
- Industrial CO Monitors
- Ventilation Control
- RV and Marine CO Monitoring
- Indoor Air Quality
- Outdoor Air Quality

DESCRIPTION

SPEC Sensors' Screen Printed ElectroChemical sensor technology (SPEC Sensor™) revolutionizes the current state of the art, enabling new applications in consumer and industrial safety monitoring. SPEC's printed sensors offer the performance of the best quality electrochemical sensors at a fraction of the price. SPEC's printed sensors are also ultra-thin, offering easy integration into wireless, portable, and networked solutions. These sensors are ideal for health, environmental, industrial and residential monitoring, because of their high performance, low cost and small size.

**Incorporates SPEC Sensors' 100-102
ETL recognized component and UL Listed Component**



Conforms to UL STDS 2034 & 2075

Certified to CSA STD 6.19-01



SPECIFICATIONS

Measurement Range	0 to 1,000 ppm
Detection Limit	0.5 ppm
Resolution	< 100 ppb (instrumentation dependent)
Repeatability	< ± 2 % of reading
Response Time – T(90)	< 30 seconds (15 seconds typical)
Sensitivity	4.75 ± 2.75 nA/ppm
Overload	Passes EN50291-1 Sec. 5.3.6 5,000 ppm overload
Expected Operating Life	> 5 years (10 years @ 23 ± 3 °C; 40 ± 10% RH)
Operating Temperature Range	-30 to 55 °C (-20 to 40 °C continuous recommended)
Operating Humidity Range – non-condensing	15 to 95% recommended continuous 0 to >95% RH - intermittent
Operating Bias	0 to 5 mV
Power Consumption	10 to 50 uW (circuit & ambient CO dependent)

TEMPERATURE EFFECT

Temperature fluctuations have a predictable, easily compensated effect on the sensor signal. The figures below show the typical Temperature dependency of the output and baseline of 3SP_CO_1000 sensors under constant humidity of 40-50 % RH. This is a very uniform and repeatable effect, easily compensated for in hardware or software.

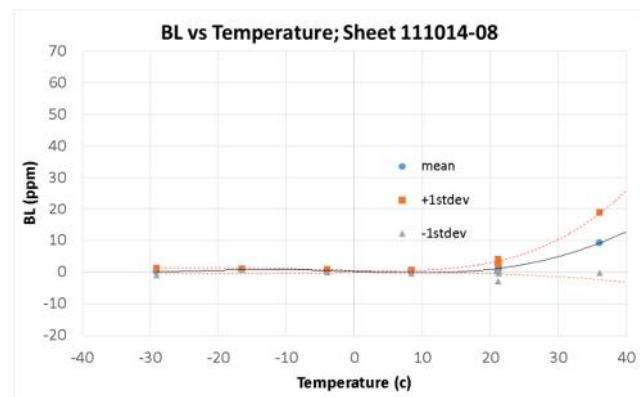
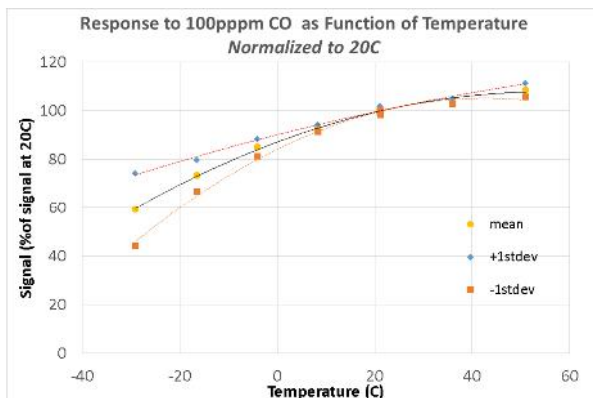

Temperature Coefficient of Span (Typical)	-20°C to 10 °C	0.9% / °C
	10°C to 40 °C	0.3% / °C
Zero shift (ppm/deg) (Typical)	-20 to 0 °C	0.06 ppm/°C
	0 °C to 25 °C	0.4 ppm/°C
	25 to 40°C	1.4 ppm/°C

LONG TERM STABILITY

The figure at right shows response of a set of 34 sensors over 12 months under standard test conditions. *Sensor output is plotted as % of the initial response to 150ppm test gas.*

(Data from UL Component Recognition Test; Nov 2014-Oct 2015.)

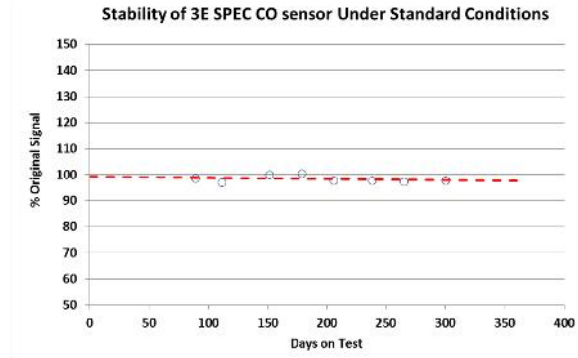

CROSS SENSITIVITY

Most chemical sensors exhibit some cross-sensitivity to other gases. The following table lists the relative response of common potential interfering gases, and the concentration at which the data was gathered.

Gas/Vapor	Concentration	Typical Response PPM CO
Carbon Dioxide	5,000 ppm	< 1
Hydrogen	100 ppm	17
Methane	3,000 ppm	< 1
Ammonia	100 ppm	< 1
Nitrogen Dioxide	10 ppm	< 1
Hydrogen Sulfide	25 ppm	< 1
Carbon Monoxide	400 ppm	400
Ozone	5 ppm	< 1
Sulfur Dioxide	20 ppm	< 1
Chlorine	10 ppm	< 1
n-Heptane	500 ppm	< 1
Toluene	200 ppm	< 1
Isopropyl Alcohol	200 ppm	1.3
Acetone	200 ppm	< 1

IMPORTANT PRECAUTIONS

All sensor designs are made for air monitoring @ 1 atm +/- 0.2 atm. Because applications of use and device implementation are outside our control, SPEC Sensors cannot guarantee performance in a given device or application, and disclaims any and all liability therefore. **Customers should test under their own conditions to ensure the sensors are suitable for their requirements.**

Contact the factory to discuss specific concerns that might damage the sensor performance or life.

- Condensation and Water (1)
- Salt Water Contamination (1)
- High Temperature Operation (> 70C) for more than 1 month
- Low Humidity Operation (< 15% RH) for more than 3 months
- High Bias voltage
- Highly contaminated air over a prolonged period
- High levels of particles or soot (unless proper filtering is provided)

(1) Use of porous PTFE membrane or filter cap may address this concern)

LOW HUMIDITY

SPEC CO sensors have been tested under low humidity conditions to ensure stable response during intermittent exposure to very dry conditions.

As shown in figure at right, presenting data collected over 3 months in <10%RH, the response of the sensor is virtually unchanged after 30 days, and remains within 20% of the initial signal over the 3 month test period..

NOTE: the 3SP-CO-1000 sensor is not intended for continuous operation at <10% RH. Extended periods (>60-90 days) of operation in <10% humidity may permanently damage the sensor.

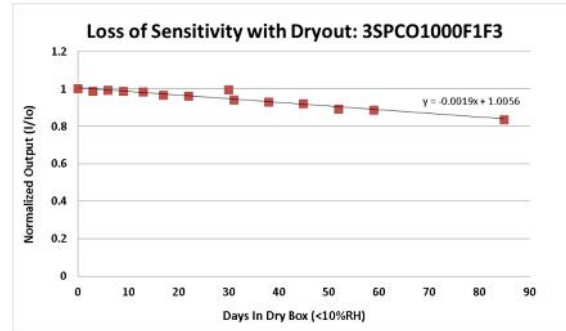

MARKING INFORMATION

All gas sensors are tested and marked at the SPEC Sensors factory. Sensors include a label with an alphanumeric code and a two-dimensional bar code. The codes include the information indicated in the table below.

	Unique Serial Number	Sensor Part Number	Target Gas	Date Code	Sensitivity Code (nA/ppm)
Alph-Numerica Code:		100102	CO	1510	4.94
2D Code:	101915010906	100102	CO	1510	4.94

DIMENSIONS

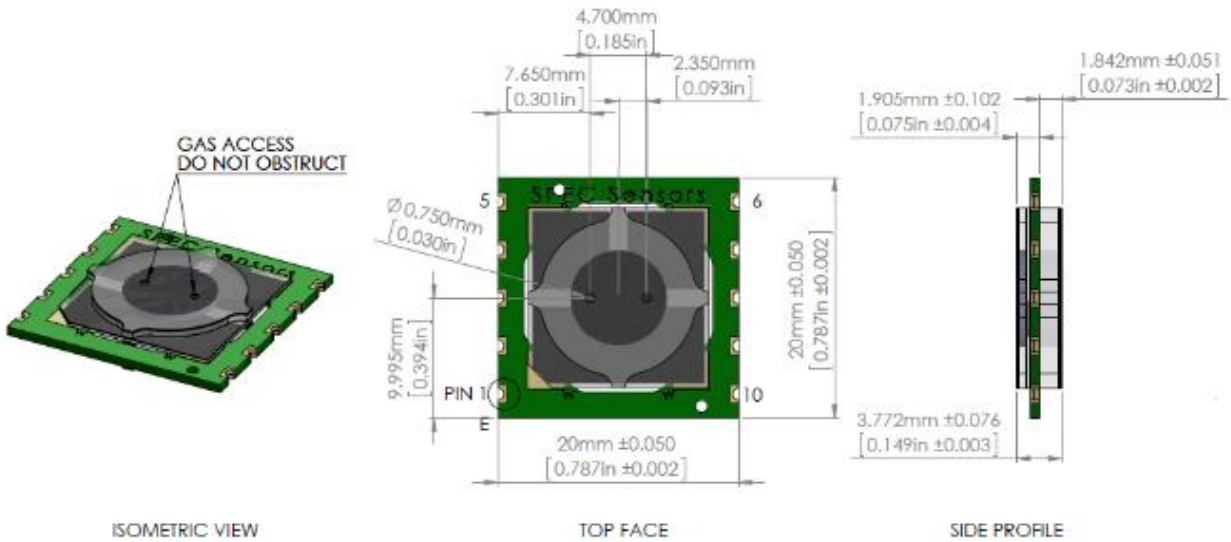

PCB LAYOUT GUIDELINES

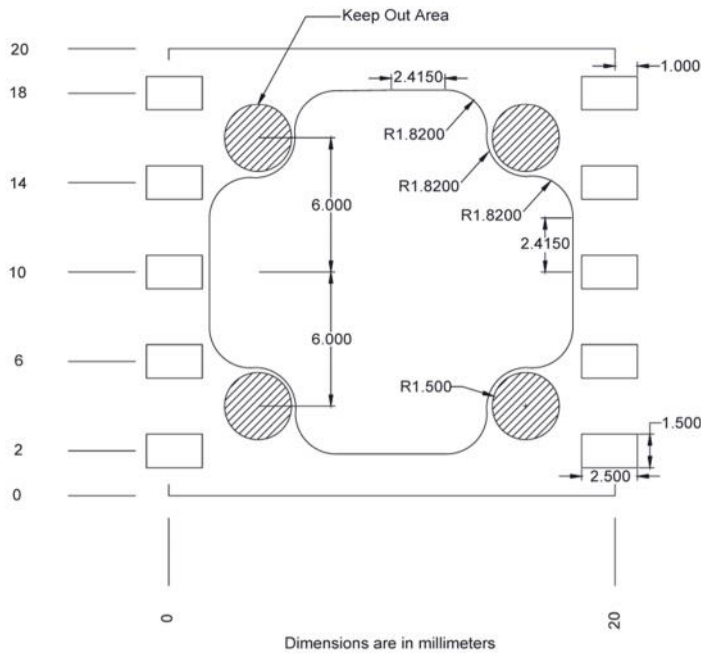

PIN	CONNECTION
1	WORKING
2	NC
3	NC
4	NC
5	REFERENCE
6	COUNTER
7	NC
8	NC
9	NC
10	WORKING

SENSOR STORAGE, HANDLING AND SOLDERING

This information embodies various general recommendations concerning the storage, handling, and manual soldering conditions for SPEC SENSORS CSPEC Modules. It is only applicable for modules guaranteed by SPEC SENSORS stated in SPEC SENSORS Sensor Specification Sheet. Moreover, SPEC SENSORS' modules are NOT warranted and should NOT be used in high temperature soldering (reflow) or pre-tinning baths.

Sensor & Module Handling

Handle sensors with care. Take precautions, including but not limited to the following:

- A. DO NOT apply excessive pressure to the top or bottom of the sensor module.
- B. Whenever possible, handle or make contact with the sensor module from the sides of the PCB or substrate.
- C. Light vacuum pressure is possible during handling, DO NOT apply vacuum over gas sensor port.
- D. If the sealed sensor package is opened, DO NOT re-seal using vacuum or nitrogen gas. DO NOT reseal with desiccant.
- E. DO NOT obstruct the gas sensor port by making direct contact with any tape, apparatus, weights, etc.
- F. DO NOT use silicone or other conformal coatings around the sensor or gas port-holes.
- G. Operators are requested to wear powder free antistatic gloves.

Manufacturing Assembly Floor Environment

SPEC SENSORS recommends that the manufacturing assembly floor environment be maintained at controlled conditions:

- A. Temperature: 18 - 26°C
- B. Relative Humidity: 40 to 60%
- C. Pressure: 1.0 ± 0.2 atm

Sensor & Module Storage Conditions

The shelf life for sealed, packaged components is 12 months from the pack seal date, when stored in the factory-sealed bag under the following conditions:

- A. Temperature: 5 to 25 °C
- B. Relative Humidity: 20 to 80%
- C. Pressure: 1.0 ± 0.2 atm
- D. Storage Time: 12 months

When moving from Storage Conditions to the Manufacturing Assembly Floor Environment, the sensors should be allowed to equilibrate at the new conditions for at least 24 hours prior to manufacturing.

Module Attach Soldering Process

Hand solder only. Keep the soldering iron or solder process tool away from the sensor. The sensor should not see pre-heat temperatures above 70 °C. There have been suggested cases where a heat sink cover over the sensor may be applicable to protect the sensor during processing. No Application notes to this approach available. Only to be used as reference only.

- A. DO NOT heat sensor above 70 °C
- B. Hand or peripheral process type approach
- C. Use solder wire alloy with the lowest possible eutectic temperature
- D. Use lowest possible soldering iron temperature
- E. Contact the host board with the soldering iron at a 45° angle on the solder pad
- F. Keep the soldering iron away from the top and bottom of the sensor module
- G. DO NOT place in reflow, wave or IR reflow type processes
- H. DO NOT place mounted board in a wash